

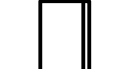

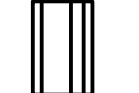
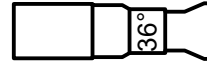

Barn door all DESIRES

CH 102 hung on 1' side arm

CH 103 hung on 1' side arm

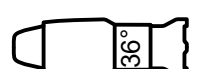
-  Altman 3in Fresnel @ 100 w
-  Altman Blacklight UV-705 @ 400w
-  Altman Spectra Cyc 100 @ 100w
-  ETC ColorSource Spot 36deg @ 160w
-  ETC D40 Lustr SELL60 @ 110w
-  ETC D40 Vivid SELR45 @ 110w
-  ETC Source4 36deg @ 575w
-  Miro Cube 4C @ 50w
-  USITT Practical @ TBD

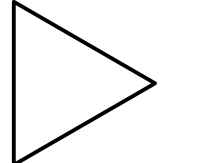
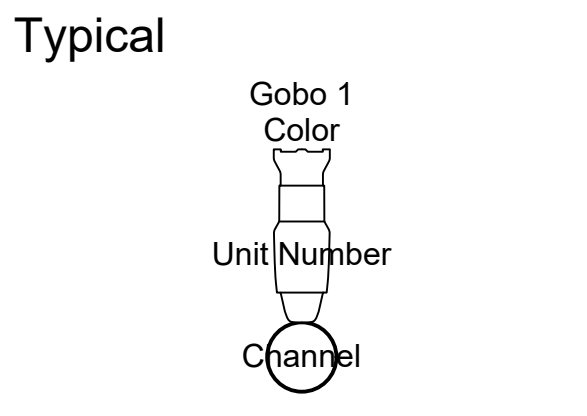

Color Summary

Color	Size	Count
R113	6.25"	31

SILENT SKY
WAGNER COLLEGE
STAGE ONE
CAMPUS RD
STATEN ISLAND, NY, 10301

DISCLAIMER:
THIS DRAWING CONTAINS A VISUAL CONCEPTION AND CONSTRUCTION SUGGESTIONS. THE LIGHTING DESIGNER AND DESIGN ASSISTANTS/ASSOCIATES ARE NOT GUARANTEED TO DETERMINE OR GUARANTEE THE STRUCTURAL INTEGRITY OR APPROPRIATENESS OF ANY CONSTRUCTION OR RIGGING METHODS, AND ASSUME NO LIABILITY OR RESPONSIBILITY FOR THE PROPER ENGINEERING, CONSTRUCTION, OR USE OF ANY AND ALL DESIGNS CONTAINED IN THIS DOCUMENT AND ELSEWHERE THROUGHOUT THE PRODUCTION. ALWAYS CONSULT A LICENSED STRUCTURAL ENGINEER BEFORE ANY RIGGING CONSTRUCTION TAKES PLACE. ALL APPLICABLE LOCAL AND NATIONAL FIRE AND LIFE SAFETY CODES MUST BE FOLLOWED AT ALL TIMES.

DRAWN BY:
ALEXANDRIA RICE

REVISION HISTORY:

Date	Description	By
09/29/25	Final	AR

PRODUCTION TEAM:
DIRECTOR:
MARIA-IOANA ANDREI
SCENIC DESIGNER:
JAREB GOLDSTON
LIGHTING DESIGNER:
ALEXANDRIA RICE
ASSOCIATE LIGHTING DESIGNER:

PRODUCTION MASTER ELECTRICIAN:
ALLISON BORIO

SCALE: 1/2" = 1'-0" DWG #: I
PGSIZE: USARCHD

LIGHT PLOT

